



General info

Technical - Systems

| | |
|--------------|--|
| Ean | 8021696268231 |
| Item | STEEL SP2 D20 BI-EMISSION WIDE 4000K BIANCO |
| Installation | Systems |
| Warranty | 5 years |
| Gross weight | 2.92 kg |
| Volume | 0.012285 m ³ |

Technical info

| | |
|-----------------------|--------------|
| Net weight | 2.55 kg |
| Insulation class | I |
| Protection index | IP20 |
| Compliance | - |
| Operating temperature | - |
| Dimmer | 1 |
| Power output | 100-240 V AC |
| Power supply | - |

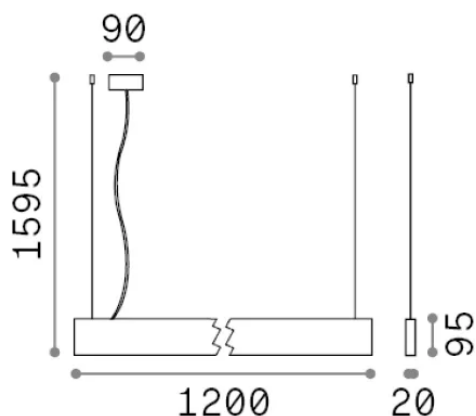

Source info

| | |
|------------------------|----------|
| Integrated source | - |
| Replaceable source | No |
| Power | 32 W |
| Emission | - |
| Max consumption | - |
| Features LED | LED SMD |
| CCT LED | 4000 K |
| Duration LED (t. 25°C) | 50 h |
| CRI | > 90 |
| SDCM | 3 |
| Light beam | 104+104° |
| Light beam flux | 5000 lm |
| Useful light flux | - |