

## Intelligent LED Driver (Constant Current)

- The casing is made of Covestro/Samsung PC flame-retardant material at the V0 level.
- Ultra-compact, lightweight, and featuring a tool-free end-cap design. Parameters such as output current and DALI address can be changed via the mobile phone APP through NFC. Advanced templates such as groups and scenes can also be set up to achieve the data interaction function of the driver.
- It supports DALI-2, PUSH DIM, and corridor light dimming.
- NFC-adjustable current steps as fine as 1mA for superior compatibility.
- With T-PWM ultra-deep dimming technology, the dimming depth can reach up to 0.01%.
- There is no visible flicker during the full-range dimming from 0 to 100%, and it meets the high-frequency exemption assessment level.
- It supports the CLO light decay compensation function to ensure constant illumination brightness.
- It supports online OTA (Over-The-Air) upgrade of the device firmware.
- The no-load power consumption and network standby power consumption comply with the EU ERP standards, being less than 0.5W.
- Automated recovery from overtemperature, overload, short-circuit, and overvoltage events.
- It is suitable for indoor Class I, II, and III lighting fixture applications.
- 100,000-hour typical lifespan (under standard use).
- It comes with a 5-year warranty (ruby capacitor-based).



**T-PWM**  
Dimming Technology

**Flicker Free**  
IEEE 1789

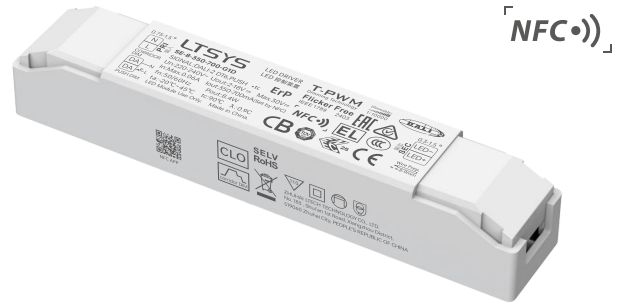

## Technical Specs

Model	<b>SE-8-100-450-G1D</b>		SE-8-350-700-G1D	
Features	Output Type	Constant current		
	Dimming Interface	DALI-2 DT6, PUSH DIM		
	Output Feature	Isolation		
	IP Rating	IP20		
	Insulation Glass	Class II (Suitable for class I/ II /III light fixtures)		
OUTPUT	Output Voltage	9-42Vdc	2-18Vdc	
	Max. Output Voltage(No-load)	≤50Vdc	≤30Vdc	
	Output Current Range	100-450mA	350-700mA	
	Output Power Range	0.9-8.4W	0.7-8.4W	
	Dimming Range	0~100%, down to 0.01%		
	LF Current Ripple	<5%(Maximum current for non dimming state)		
	Current Accuracy	±5%		
INPUT	PWM Frequency	≤3600Hz		
	AC Voltage Range	220-240Vac		
	DC Voltage Range	220-240Vdc(Not assessed)		
	Input Voltage	230Vac		
	Frequency	50/60Hz		
	Input Current	≤0.06A/230Vac		
	Power Factor	PF>0.9/230Vac (at full load)		
	Efficiency (Typ.)	> 80%	> 78%	
	Inrush Current	Cold start 15A(Test twidth=300us tested under 50% Ipeak)/230Vac		
	Anti Surge	L-N:1KV		
Leakage Current	Max.0.5mA			
ENVIRONMENT	Operating Temperature	ta:-20~45°C tc:90°C		
	Working Humidity	20 ~ 95%RH, non-condensing		
	Storage Temperature/Humidity	-40~80°C/10~95%RH		
	Temperature Coefficient	±0.03%/°C(-20°C-45°C)		
	Vibration	10~500Hz, 2G 12min/1cycle, 72 min for X, Y and Z axes respectively		
PROTECTION	Overload Protection	Automatically protect the device when the load exceeds 102% of the rated power. Automatically recover once load is reduced		
	Overheat Protection	Intelligently adjust or turn off the current output if the PCB temperature ≥110°C. When the PCB temperature <90°C, automatically recover normal output		
	Overvoltage Protection	Automatically protect the device when voltage exceeds the no-load voltage. It can be recovered automatically		
	Short Circuit Protection	Enter hiccup mode if short circuit occurs, and recover automatically		
SAFETY & EMC	Withstand Voltage	I/P-O/P: 3750Vac		
	Insulation Resistance	I/P-O/P: 100MΩ/500VDC/25°C/70%RH		
	Safety Certifications	CCC	China	GB19510.1, GB19510.14, GB19510.213
		TUV	Germany	EN61347-1, EN61347-2-13, EN62493
		CB	CB Member States	IEC61347-1, IEC61347-2-13
		CE	European Union	EN61347-1, EN61347-2-13, EN62384
		EAC	Russia	IEC61347-1, IEC61347-2-13
		RCM	Australia	AS 61347-1, AS 61347-2-13
		ENEC	Europe	EN61347-1, EN61347-2-13, EN62384
	EMC Emission	CCC	China	GB/T17743, GB17625.1
		CE	European Union	EN55015, EN61000-3-2, EN61000-3-3, EN61547
		EAC	Russia	IEC62493, IEC61547, EH55015
RCM		Australia	EN55015, EN61000-3-2, EN61000-3-3, EN61547	
EMC Immunity		EN61000-4-2,3,4,5,6,8,11, EN61547		
ErP	Power Consumption	Networked standby	< 0.5W (After shutdown by command)	
		No-load power consumption	< 0.5W (When the lamp is not connected)	
	Flicker/Stroboscopic Effect	IEEE 1789 CIE SVM	Meet IEEE 1789 standard/High frequency exemption level Pst LM≤1.0, SVM≤0.4	
OTHERS	Weight(N.W.)	50g±5g		
	Dimensions	119×22×20mm(L×W×H)		

## Product Size

Unit: mm

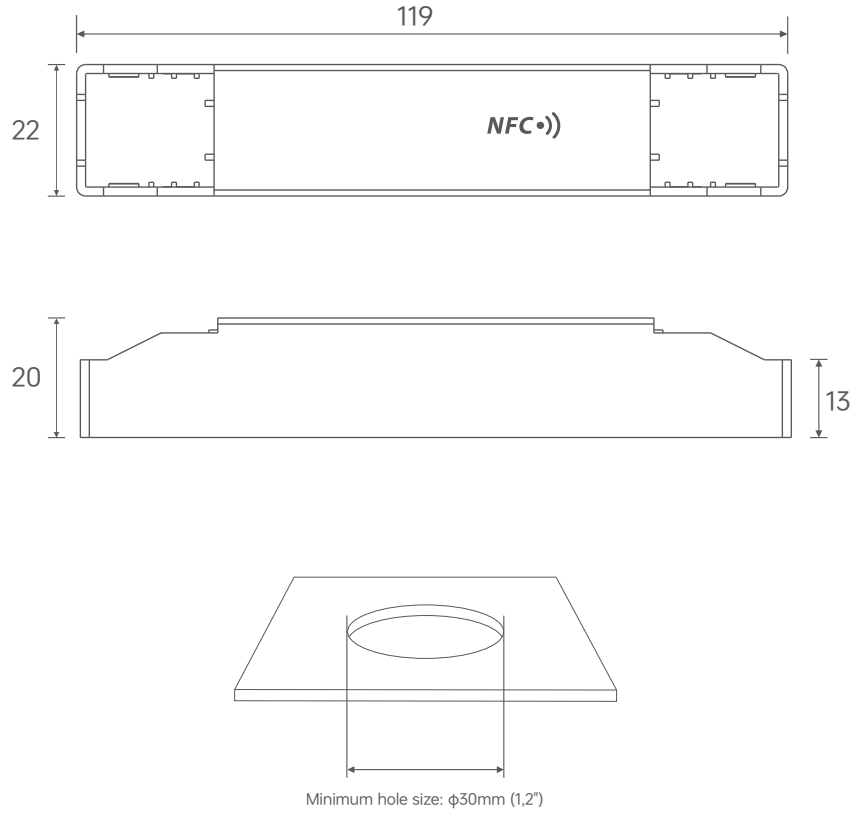

## DALI Dimming Application

### wiring diagram

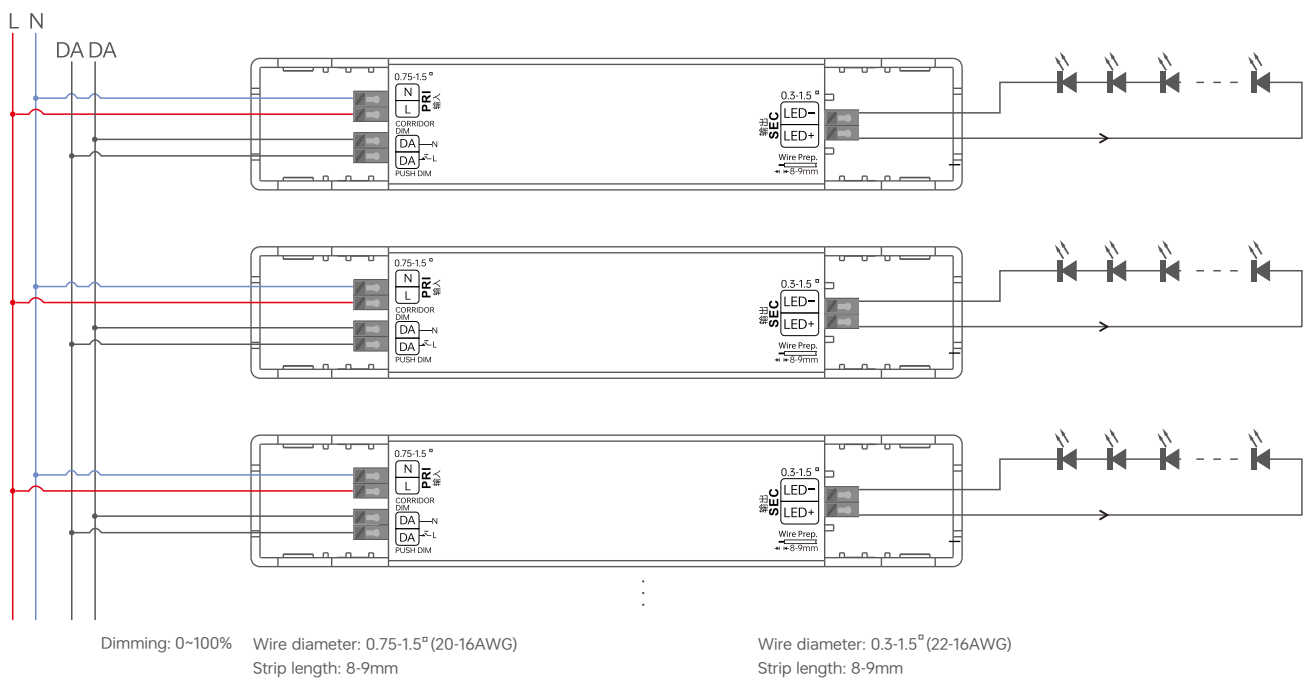

### Switch to DALI Dimming Mode.

After installation according to the wiring diagram of the DALI dimming application, the driver will automatically switch to the DALI dimming mode upon receiving any DALI command.

## PUSH DIM Dimming Application

### wiring diagram

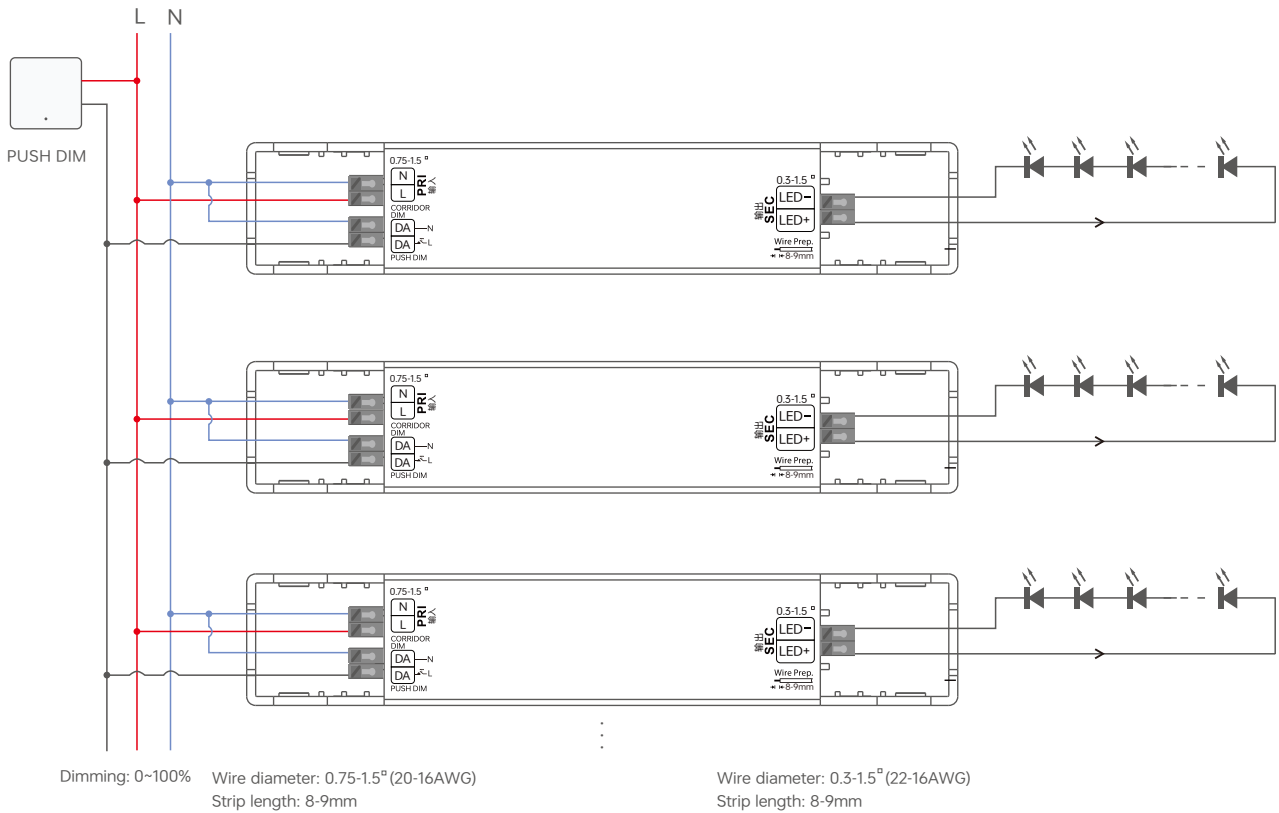

### Switch to the Push-DIM dimming mode

Method 1: If it has been switched to the corridor dimming mode, connect the wires according to the Push DIM wiring diagram. Press the switch briefly 5 times within 3 seconds of reset button, then press and hold it for 6 seconds, and then press it briefly 5 times within 3 seconds. The driver will automatically switch to the Push DIM dimming mode.

Method 2: If it is switched to the corridor mode, you can switch to the Push DIM dimming mode through the NFC Lighting app.

Remarks: If the DALI master controller is not connected, the default mode is the Push DIM mode at the factory.

### Operation Instructions



PUSH DIM

**Short press for on/off control.**

**Double click: Not available.**

**Long press: Adjust the current brightness.**

**Dimming memory: When the light is switched on/off again, the light will resumes to the previously set brightness level.**

## Corridor Dimming Application

### wiring diagram

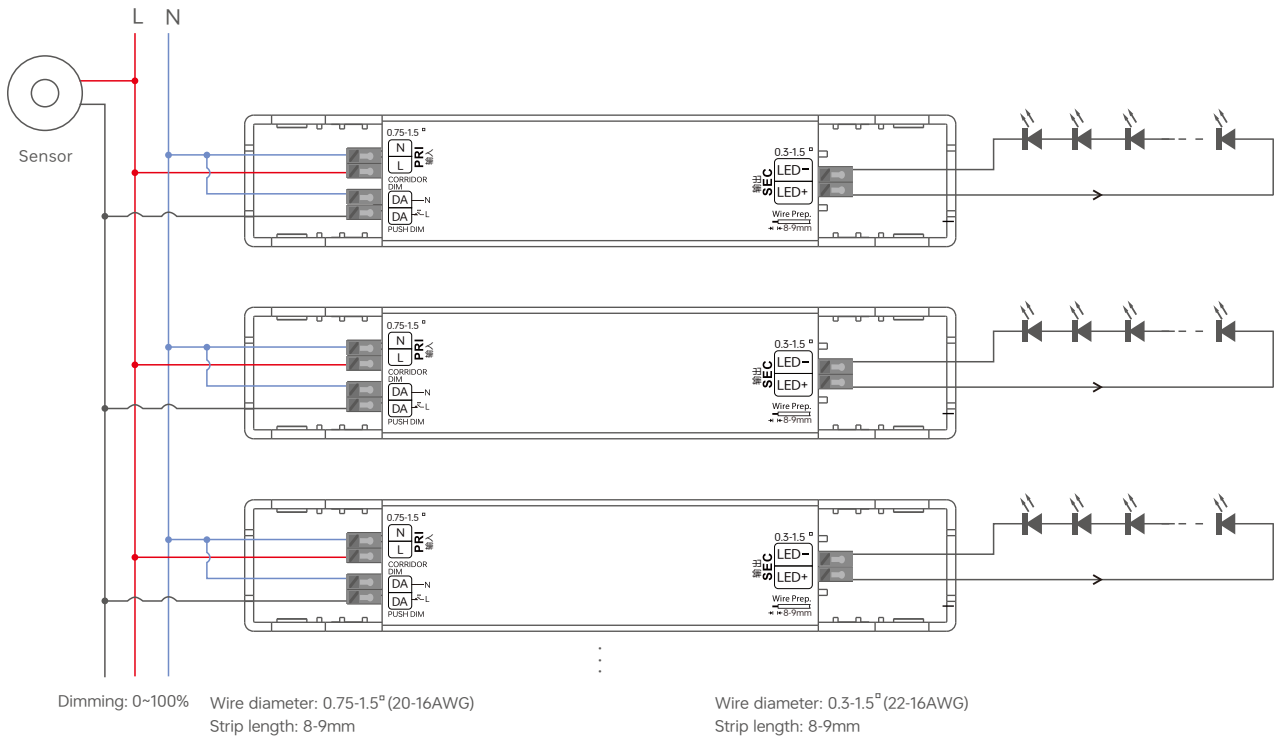

### Switch to the corridor light mode

**Method 1:** Configure and switch the corridor light function via NFC, and the Push DIM function will be turned off.

**Method 2:** After connecting the wires according to the corridor dimming wiring diagram, keep moving within the effective sensing area for more than 2 minutes, and it will automatically switch to the corridor dimming mode with all lights on at full brightness.

**Method 3:** After connecting the wires according to the corridor dimming wiring diagram, first replace the sensor with a common switch, then turn on the common switch and keep it conducting for 2 minutes. The driver will automatically switch to the corridor dimming mode. After that, remove the common switch and replace it with the sensor again.

Remarks: During normal operation, it is recommended to set the hold-time of the motion sensor to the minimum.

It is necessary to select a motion sensor with an AC switch.

## Corridor Dimming: Working Process

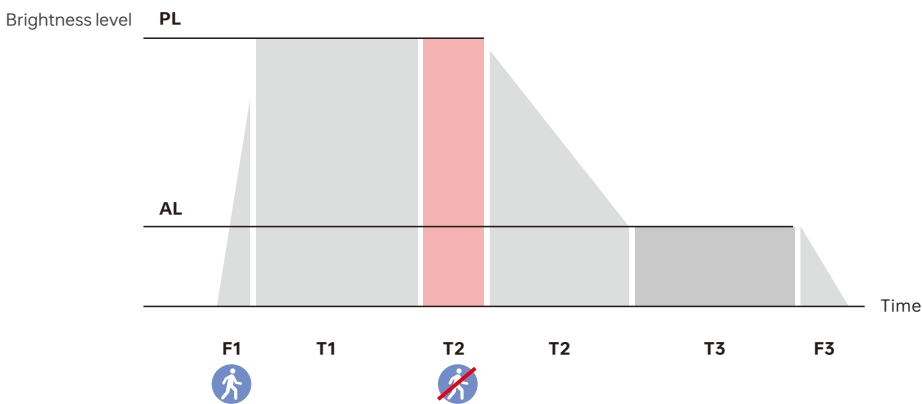

Name	Default	Setting Range
(F1) Gradual Entry Sensing Time	1 s	0-100 s
(PL) Sensing Brightness	255	0-255
(T1) Sensing Holding Time	Set through the sensor	
(T2) Delay Time	30 s	0 s, 5 s, 10 s, 20 s, 30 s, 45 s, 1 min, 2 s, 3 s, 5 s, 10 s, 20 s, 30 s
(F2) Gradual Exit Sensing Time	1 s	0-100 s
(AL) Standby Brightness	100	0-255
(T3) Sensing Standby Time	30 s	0 s, 5 s, 10 s, 20 s, 30 s, 45 s, 1 min, 2 mins, 3 mins, 5 mins, 10 mins, 20 mins, 30 mins, Permanent
(F3) Gradual Exit to Off Time	1 s	0-100 s

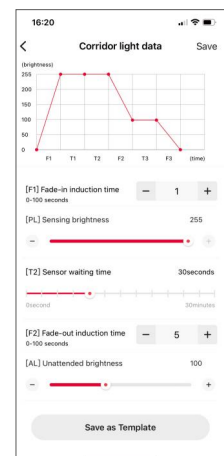

Remarks: \*If the lamp needs to be on standby at a low brightness level, the [T3] Sensing Standby Time should be set to "Permanent".

\*The above parameters are set through the NFC lighting APP.

## Typical Current Corresponding Parameter Table

The following 8 groups of typical current data are provided for model selection reference. More currents can be set via the mobile phone APP NFC. The settable range is 100-450mA, and the current step value can be as low as 1mA.

SE-8-100-450-G1D	Output Current	100mA	150mA	200mA	250mA	300mA	350mA	400mA	450mA
	Output Voltage	9-42Vdc	9-42Vdc	9-42Vdc	9-33.6Vdc	9-28Vdc	9-24Vdc	9-21Vdc	9-18.6Vdc
	Output Power	0.9-4.2W	1.35-6.3W	1.8-8.4W	2.25-8.4W	2.7-8.4W	3.15-8.4W	3.6-8.4W	4.05-8.4W

The following 8 groups of typical current data are provided for model selection reference. More currents can be set via the mobile phone APP NFC. The settable range is 350-700mA, and the current step value can be as low as 1mA.

SE-8-350-700-G1D	Output Current	350mA	400mA	450mA	500mA	550mA	600mA	650mA	700mA
	Output Voltage	2-18Vdc	2-18Vdc	2-18Vdc	2-16.8Vdc	2-15.2Vdc	2-14Vdc	2-12.9Vdc	2-12Vdc
	Output Power	0.7-8.4W	0.8-8.4W	0.9-8.4W	1-8.4W	1.1-8.4W	1.2-8.4W	1.3-8.4W	1.4-8.4W

## Protective Housing Application Diagram



1. Use a tool to pry up the protective cover on the side panel.

2. Use a screwdriver to press the terminal for wiring.

3. Use a screwdriver to press the terminal for wiring.

4. Close the protective cover.

## Installation Precautions

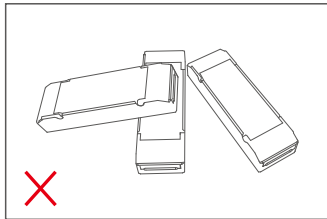

Please do not stack the products. The distance between two products should be  $\geq 15\text{cm}$  so as not to affect heat dissipation and the lifespan of the products.

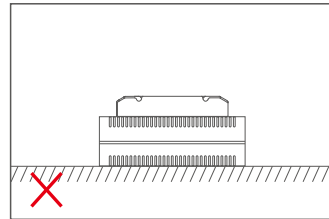
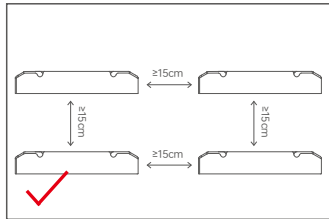

Please do not place the products on LED drivers. The distance between the product and the driver should be  $\geq 15\text{cm}$  so as not to affect heat dissipation and shorten the lifespan of the products.

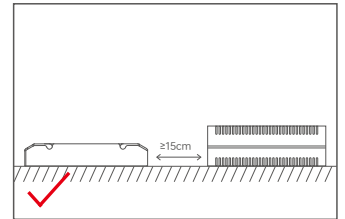

Note: The installation should be in line with the environmental operating temperature of the product. Do not install it inside the lamp to avoid exceeding the environmental operating temperature of the product, which may affect the product's lifespan.

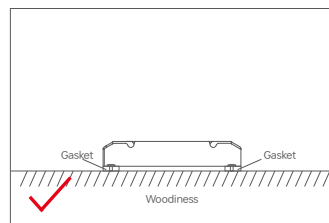
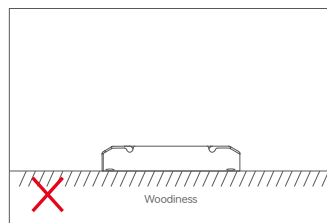

Do not fix the product screws tightly against the wooden board. Instead, add a washer with a thickness of  $\geq 7\text{mm}$  under the fixing screws. Leaving some gaps can effectively dissipate heat, preventing any impact on the product's heat dissipation performance and service life.

## Use the NFC Lighting APP

Scan the QR code below with your mobile phone and follow the prompts to complete the APP installation (According to performance requirements, you need to use a NFC-capable Android phone, or an iPhone 8 and later that are compatible with iOS 13 or higher).



\* Before you begin setting the parameters of the driver, please ensure the driver is powered off.

### Read/Write the LED driver

Use your NFC-capable phone to read LED driver data, then edit the parameters and they can be directly written to the driver.

#### 1. Read the LED driver

On the APP home page, click **【Read/Write LED driver】**, then keep the programmer's sensing area close to the NFC logo of the driver to read the driver parameters.



#### 2. Edit the parameters

Click **【Parameter Management】** to edit more advanced parameters such as output current, DALI address, dimming curve, brightness range, dimming gradient time, power-on status, system failure status, light decay compensation, corridor light, and DALI template settings.

#### 3. Write to the driver

After completing the parameter settings, click **【Write】** in the upper right corner, and keep the programmer's sensing area close to the NFC logo of the driver, so the parameters can be written to the driver.

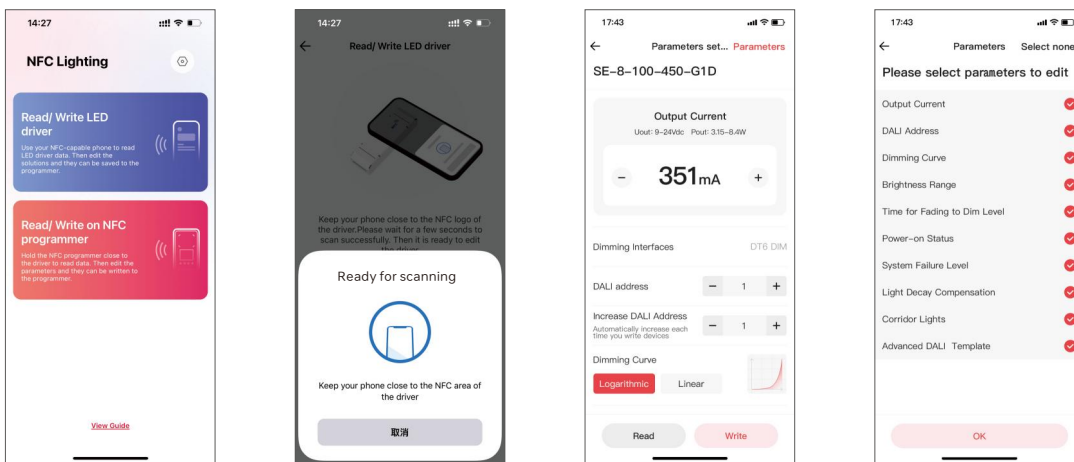

### Advanced DALI template

Integrate the functions of the DALI lighting system, edit the DALI group and lighting effects for scenes, then save them in the advanced template to achieve lighting programming.

Setup page (for Read/Write LED driver) : Go to App home page — **【☰】** icon in the top right — **【DALI template on phone】** .

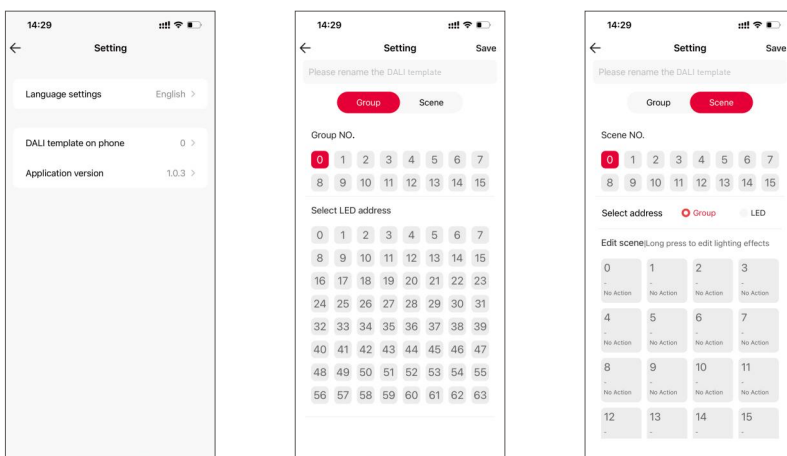

### Relationship Diagrams

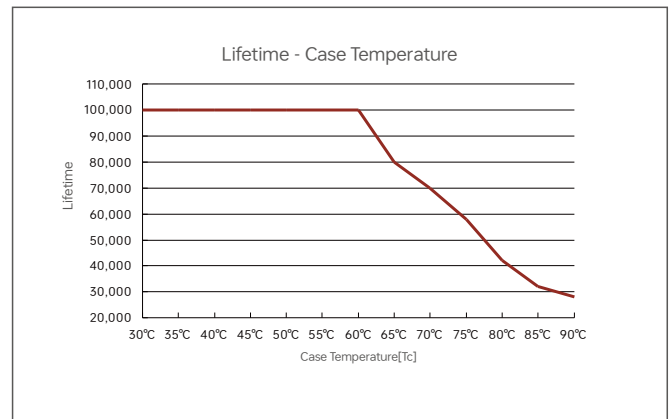
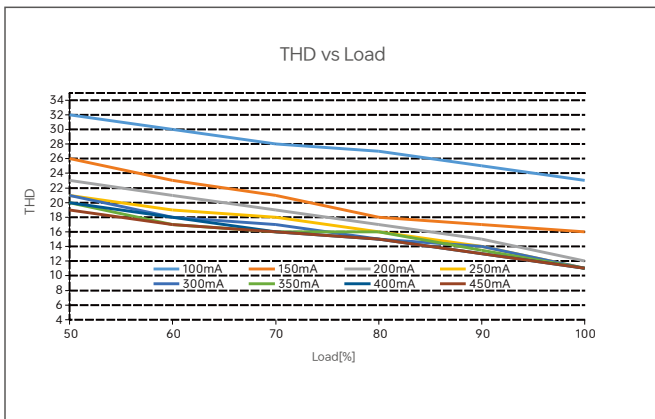
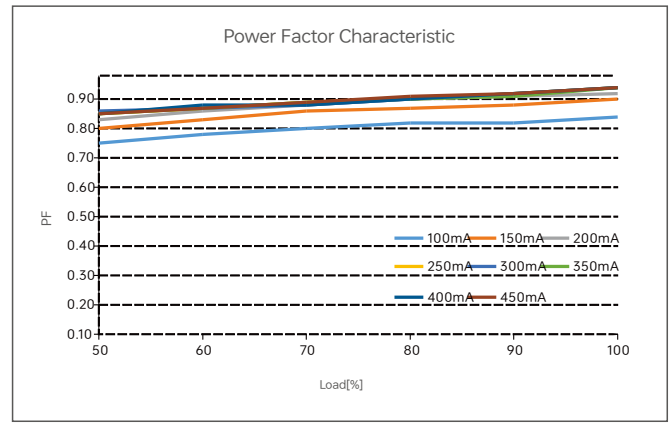
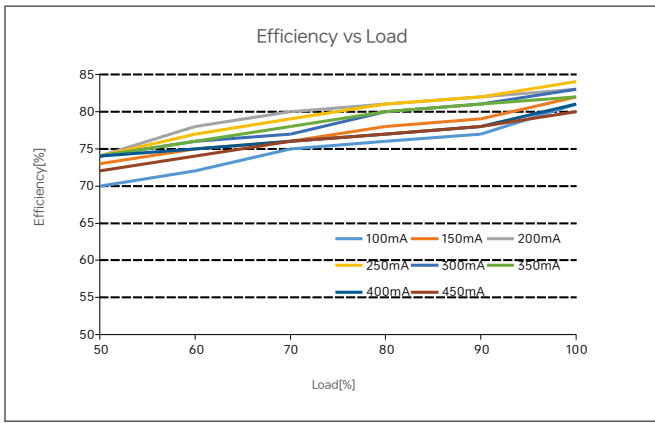

SE-8-100-450-G1D

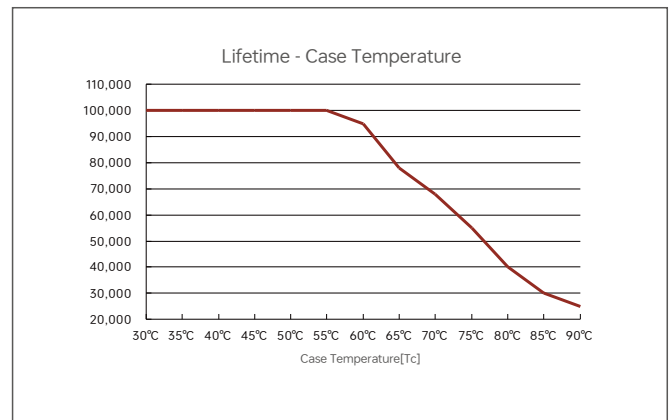
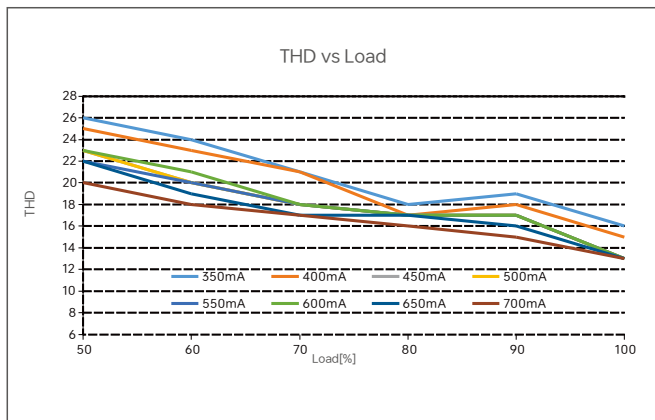
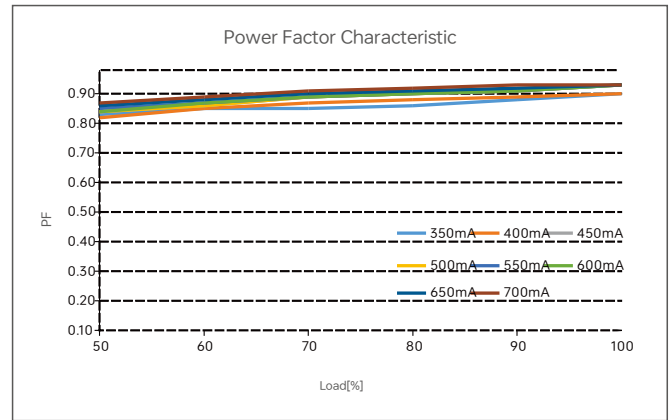
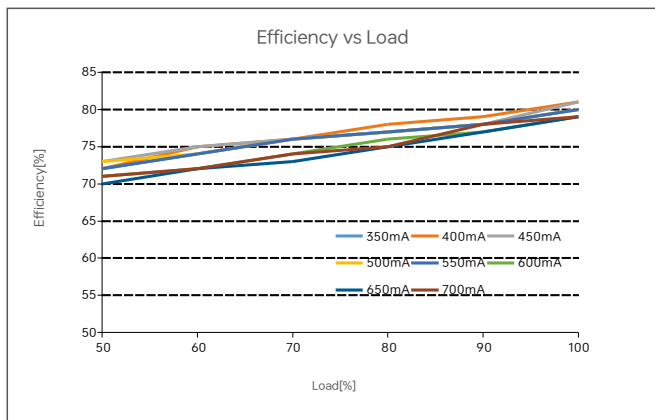

SE-8-350-700-G1D

## Flicker Test Sheet

IEEE 1789

Limit of modulation in low risk area	
Waveform frequency of optical output	limit (%)
$f \leq 8\text{Hz}$	0.2
$8\text{Hz} < f \leq 90\text{Hz}$	$0.025 \times f$
$90\text{Hz} < f \leq 1250\text{Hz}$	$0.08 \times f$
$f > 1250\text{Hz}$	Exemption assessment
Limit of modulation in no effect area	
Waveform frequency of optical output	limit (%)
$f \leq 10\text{Hz}$	0.1
$10\text{Hz} < f \leq 90\text{Hz}$	$0.01 \times f$
$90\text{Hz} < f \leq 3125\text{Hz}$	$(0.08/2.5) \times f$
$f > 3125\text{Hz}$	Exemption assessment (High frequency exemption)

- Brightness
- ▲ 0.1%
  - ◆ 1%
  - ▲ 5%
  - ◆ 10%
  - 20%
  - ▲ 30%
  - 40%
  - ★ 50%
  - 60%
  - 70%
  - ◆ 80%
  - ★ 90%
  - ◆ 100%

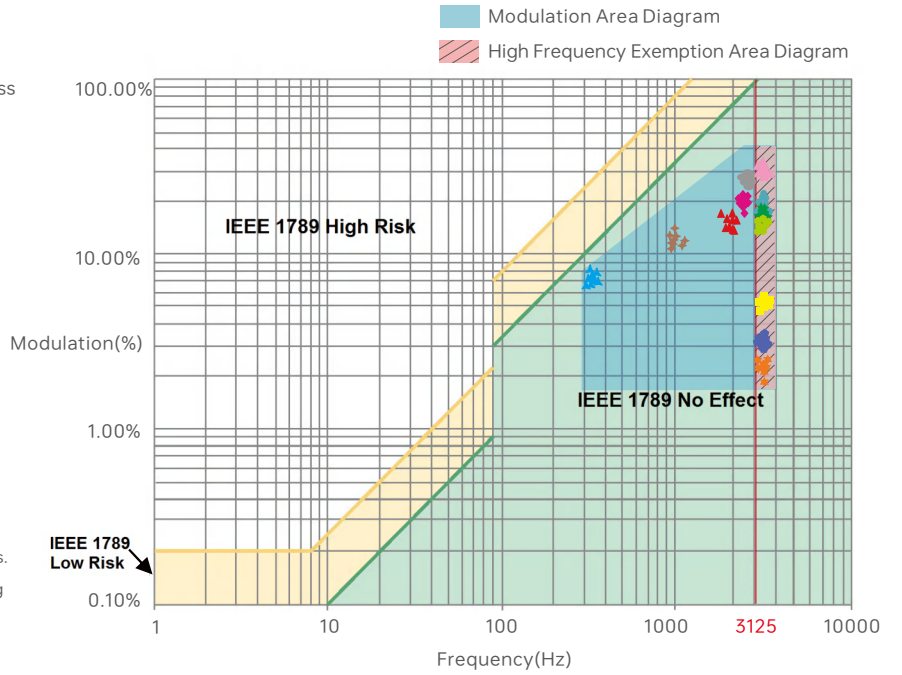

Marks in the right chart were tested results of different current ranges. The output frequency is 0Hz in 100% brightness and its corresponding modulation is 0%, which could not be shown in the right chart.

## Packaging Specifications

Model	SE-8-100-450-G1D/SE-8-350-700-G1D
Carton Dimensions	305×255×140mm(L×W×H)
Quantity	20 PCS/Layer; 5 Layers/Carton; 100 PCS/Carton
Weight	0.05 kg/PC; 5.0 kg±5%/Carton

## Packaging Image

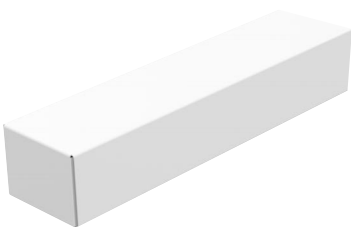

Inner Packaging Box



Carton Packaging

## Transportation and Storage

### 1. Transportation

Products can be shipped via vehicles, boats and planes.

During transportation, products should be protected from rain and sun. Please avoid severe shock and vibration during the loading and unloading process.

### 2. Storage

The storage conditions should comply with the Class I Environmental Standards. The products that have been stored for more than six months are recommended to be re-inspected and can be used only after they have been qualified.

## Attentions

- This product must be installed and adjusted by a qualified professional.
- This product is non-waterproof (special models excepted). Please avoid the sun and rain. When installed outdoors, please ensure it is mounted in a water proof enclosure.
- Good heat dissipation will extend the life the product. Please install the product in a environment with good ventilation.
- When you install this product, please avoid being near a large area of metal objects or stacking them to prevent signal interference.
- Please keep the product away from a intense magnetic field, a high pressure area or a place where lightning is easy to occur.
- Please check whether the working voltage used complies with the parameter requirements of the product.
- Before you power on the product, please make sure all the wiring is correct in case of incorrect connection that may cause a short circuit and damage the components, or trigger a accident.
- If a fault occurs, please do not attempt to fix the product by yourself. If you have any question, please contact the supplier.

\* This manual is subject to changes without further notice. Product functions depend on the goods. Please feel free to contact our official distributors if you have any question.

## Warranty Agreement

- Warranty periods from the date of delivery: 5 years.
- Free repair or replacement services for quality problems are provided within warranty periods.

Warranty exclusions below:

- Beyond warranty periods.
- Any artificial damage caused by high voltage, overload, or improper operations.
- Products with severe physical damage.
- Damage caused by natural disasters and force majeure.
- Warranty labels and barcodes have been damaged.
- No any contract signed by LTECH.

1. Repair or replacement provided is the only remedy for customers. LTECH is not liable for any incidental or consequential damage unless it is within the law.
2. LTECH has the right to amend or adjust the terms of this warranty, and release in written form shall prevail.

## Update Log

Version	Updated Time	Update Content	Updated by
A0	20250429	Original version	Li Haipeng
A1	20250813	Update the logo and product screen printing	Li Haipeng
A2	20251227	Introduction to New Highlighted Features	Li Haipeng
A3	20260117	Update certification-related labels	Li Haipeng