

IT DALI 30/220-240/700 CS

ICUTRONIC DALI CS | Constant Current Compact – Dimmable



Product family features

- Supply voltage: 220...240 V
- Line voltage: 198...264 V
- Line frequency: 0 Hz | 50 Hz | 60 Hz
- Lifetime: up to 50,000 h (temperature at max. t_c)
- Type of protection: IP20

Product family benefits

- Safety ensured by OSRAM (SELV)
- DALI-2 certified
- High flexibility due to eight different output currents
- Touch DIM application: easy to control via pushbutton or sensor
- Easy to use in corridors and restrooms because of three-level Corridor function
- Higher quality of light thanks to low output ripple current
- Small housing for flexible luminaire designs
- Housing from 80% recycled plastic

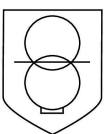

Specifications are subject to changes without notice.

www.inventronicsglobal.com

© 2024, Inventronics GmbH. All rights reserved. Inventronics is a licensee of the OSRAM brand. OSRAM is a trademark of ams OSRAM

support@inventronicsglobal.com

Areas of application

- Offices
- Shops
- Hospitality
- Panels, spotlight, downlight, and other indoor LED luminaires
- Suitable for indoor SELV equivalent installations
- Suitable for luminaires of protection classes I and II
- Installation in emergency lighting systems according to IEC 61347-2-3, appendix J

Technical data

Electrical data

Nominal input voltage	220...240 V
Mains frequency	0/50/60 Hz
Input voltage AC	198...264 V ¹⁾
Input voltage DC	176...276 V
Current set	DipSwitch
Total harmonic distortion	< 10 % ²⁾
Power factor λ	0.93...0.98
Efficiency in full-load	88 % ³⁾
Device power loss	3.8 W ⁴⁾
Protective conductor current	<0.7 mA
Inrush current	30 A ⁵⁾
Max. ECG no. on circuit breaker 10 A (B)	25
Max. ECG no. on circuit breaker 16 A (B)	40
Surge capability (L/N-Ground)	2 kV
Surge capability (L-N)	1 kV
Nominal output voltage	15...42 V ⁶⁾
U-OUT (working voltage)	60 V
Nominal output current	350 mA / 400 mA / 450 mA / 500 mA / 550 mA / 600 mA / 650 mA / 700 mA ⁷⁾
Default output current	700 mA
Output current tolerance	± 5 %
Output ripple current (100 Hz)	< 5 % ⁸⁾
Output PSTLM	≤ 1
Output SVM	≤ 0.4
Nominal output power	5.3...29.4 W ⁹⁾
Maximum output power	29.4 W
Galvanic isolation DALI/mains	Basic
Galvanic isolation DALI/output	SELV
Networked standby power	<0.50 W ³⁾

1) Permitted voltage range

2) At full load, 220...240 V, 50 Hz / see graphs

3) at 230 V, 50 Hz

4) Maximum / Full load, 230 Vac, 50Hz / 60Hz

5) $t_{width} = 100 \mu s$ (measured at 50 % I_{peak})

6) Maximum 60 V

7) Default current 700 mA

8) Ripple average at 100 Hz

9) Partial load 5.3...29.4 W

Typical Power Factor v Load

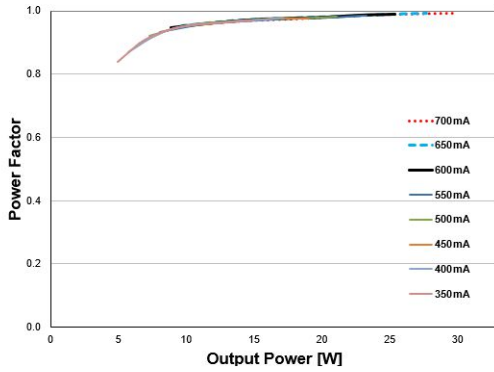

Operating Window

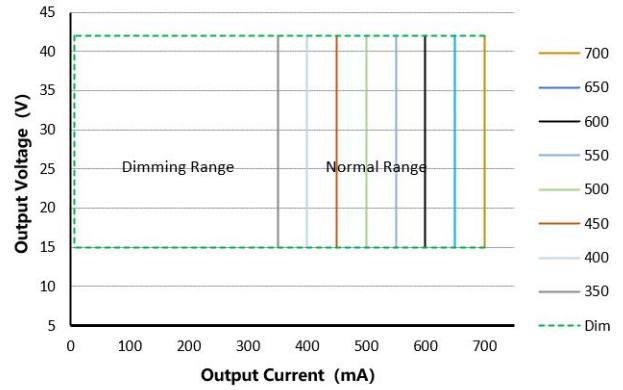

IT DALI 30 220 240 700 CS Typical Power Factor Vs Load

IT DALI 30 220 240 700 CS Typical Operating Window

Typical THD v Load

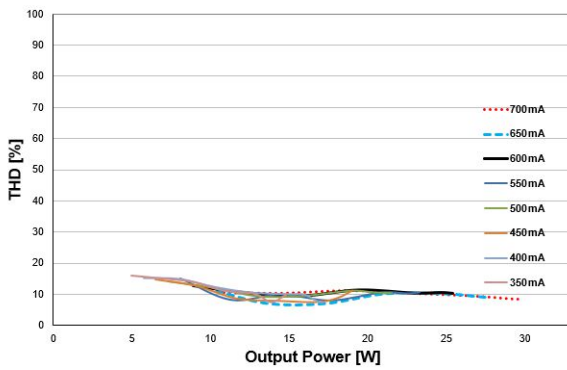

Typical Efficiency v Load 230 V 50 Hz

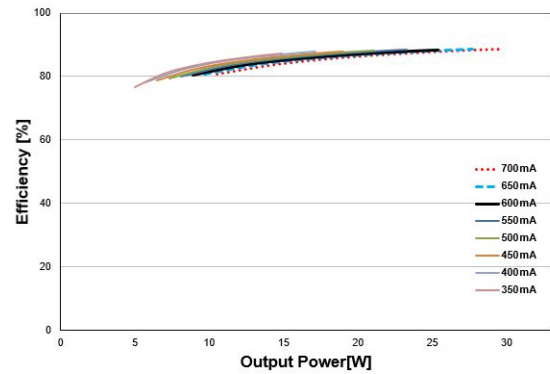

IT DALI 30 220 240 700 CS Typical THD Vs Load

IT DALI 30 220 240 700 CS Typical Efficiency Vs Load 230V 50Hz

Dimensions & weight

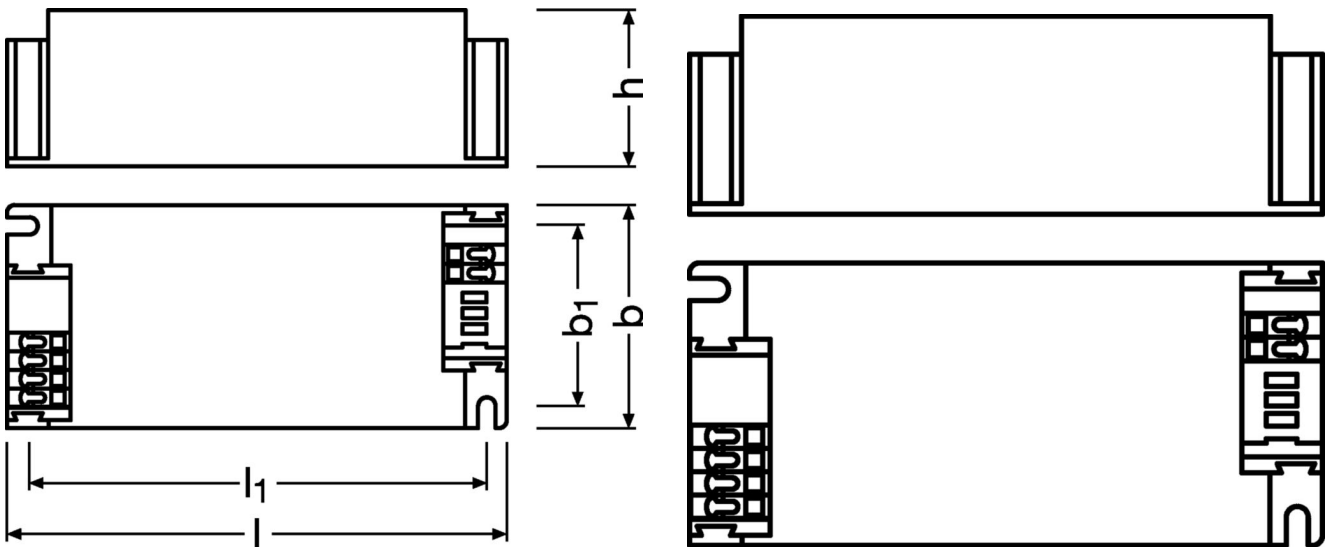

Length	97.0 mm
Width	43.0 mm
Height	29.5 mm
Mounting hole spacing, length	88.0 mm
Mounting hole spacing, width	34.0 mm
Cable cross-section, input side	0.5...1.5 mm ² / 0.75...1.5 mm ² ¹⁾
Cable cross-section, output side	0.5...1.5 mm ² / 0.75...1.5 mm ² ¹⁾
Wire preparation length, input side	7...8 mm
Wire preparation length, output side	7...8 mm
Product weight	112.50 g

1) Build in/ Independent

Colors & materials

Casing material	Plastic
Product color	White

Temperatures & operating conditions

Ambient temperature range	-20...+50 °C
Maximum temperature at tc test point	80 °C ¹⁾
Max.housing temperature in case of fault	110 °C
Temperature range at storage	-20...85 °C
Permitted rel. humidity during operation	5...85 % ²⁾

1) Maximum at the Tc-point

2) Maximum 56 days/year at 85 %

Lifespan

ECG lifetime	50000 h ¹⁾
---------------------	-----------------------

1) At maximum $T_c = 80^\circ\text{C}$ / 10% failure rate

Additional product data

Encapsulated	No
---------------------	----

Capabilities

Programming interface	Dipswitch
Control interface	DALI-2
Dimmable	Yes
Dimming interface	DALI-2 / Touch DIM / Corridor
Dimming range	1...100 % ¹⁾
Dimming method	Amplitude Modulation
Constant lumen function	No
Max. cable length to lamp/LED module	2.0 m ²⁾
Suitable for fixtures with prot. class	I / II
Suitable for emergency lighting	Yes
Type of connection, input side	Push terminal
Type of connection, output side	Push terminal
Suitable for through-wiring	No
Number of channels	1
Overheating protection	Automatic reversible
Overload protection	Automatic reversible
Short-circuit protection	Automatic reversible
Intended for no-load operation	No
No-load proof	Yes

1) For maximum nominal output current

2) Output wires must be routed as close as possible to each other

Programming

Programming device	DALI / DIPswitch
Tuner4TRONIC	Yes
Tuner4TRONIC Field App	No
Box programming	No

Programmable features

Emergency Mode	Yes
DALI Settings	Yes
TouchDIM + Sensor	Yes
Corridor Functionality	Yes
Dim to Dark	No
Soft Switch Off	No
Tuning Factor	No
Configuration Lock	Yes
Driver Guard	No
Emergency Mode	Yes

Certificates & standards

Approval marks – approval	CE / ENEC / EL / RCM / UKCA / CCC / KC / BIS
Standards	Acc. to IEC 61347-1 / Acc. to IEC 61347-2-13 / Acc. to EN 55015 / Acc. to IEC 61547 / Acc. to IEC 61000-3-2 / Acc. to IEC 62384
Type of protection	IP20
Protection class	II

Logistical data

Commodity code	85044083900
----------------	-------------

Environmental information

Information according Art. 33 of EU Regulation (EC) 1907/2006 (REACH)	
Date of Declaration	24-06-2024
Primary Article Identifier	4062172306232
Declaration No. in SCIP database	In work

Download Data

File		
Certificates	PDF	▶IT DALI CS ENEC 64142225005703 U6 020623
Product Datasheet	PDF	▶Technical Datasheet IT DALI 30 CS
CAD data	Compressed	▶IT DALI CS STEP 050623
CAD data PDF	Compressed	▶IT DALI CS CAD3PDF 050623
Mandatory Publications	PDF	▶IT DALI CS CE 4414207 02 120623
Mandatory Publications	PDF	▶IT DALI CS UK DoC 4414208 01 120623
User instruction	PDF	▶ICUTRONIC LED Power Supply

Ecodesign regulation information:

Intended for use with LED modules.

The forward voltage of the LED light source shall be within the defined operating window of the control gear in all operating conditions including dimming if applicable.

Separate control gear and light sources must be disposed of at certified disposal companies in accordance with Directive 2012/19/EU (WEEE) in the EU and with Waste Electrical and Electronic Equipment (WEEE) Regulations 2013 in the UK. For this purpose, collection points for recycling centres and take-back systems (CRSO) are available from retailers or private disposal companies, which accept separate control gear and light sources free of charge. In this way, raw materials are conserved and materials are recycled.

Logistical Data

Product code	Product description	Packaging unit (Pieces/Unit)	Dimensions (length x width x height)	Volume	Gross weight
4062172306232	IT DALI 30/220-240/700 CS	Shipping carton box 20 Pieces	228 x 208 x 78 mm	3.70 dm ³	2453.00 g

The mentioned product code describes the smallest quantity unit which can be ordered. One shipping unit can contain one or more single products. When placing an order, for the quantity please enter single or multiples of a shipping unit

Data privacy

This OSRAM driver can be configured using the Tuner4TRONIC software. This requires registering on www.myosram.com and downloading the Tuner4TRONIC software from the Internet. The Tuner4TRONIC software enables users to access and view the operational data of a luminaire or driver via the corresponding programming interfaces. A password key (Config Lock) must be set up in the driver via the Tuner4TRONIC software in order to control which users can access and view operational data. Follow the instructions for password setup. To grant an external person or company rights to access or view operational data, you can assign password keys. In this case, however, you are responsible for ensuring that the third party concerned takes notice of the information described here.

However, OSRAM can read out operating data from devices for maintenance and service purposes even when a password key has been assigned. In individual cases, OSRAM will also use its access rights in order to optimize or improve driver hardware and driver functions. In accordance with data privacy principles, any user of operating data (luminaire manufacturers, third parties with access rights) must ensure that personal data (e.g. name, address, location IDs) are only merged with the prior written consent of the person (end user) concerned. The respective user of the operating data is responsible for providing evidence of consent.

Accessories Optional

Product description	Accessory name	Accessory code
IT DALI 30/220-240/700 CS	OT CABLE CLAMP D-STYLE	▶ 4052899077904
IT DALI 30/220-240/700 CS	OT CABLE CLAMP D-STYLE	▶ 4062172345507
IT DALI 30/220-240/700 CS	OT CABLE CLAMP D-STYLE DA TL	▶ 4062172349208

Disclaimer

Subject to change without notice. Errors and omission excepted. Always make sure to use the most recent release.

Touch DIM-/Corridor Function for QUICKTRONIC DALI and OPTOTRONIC DALI

1. Touch DIM Function

1.1 Dim up to 20 DALI-ECG/DALI-LED-drivers using commercial pushbuttons



In addition to operation on DALI control units, QTi DALI ECGs / OTi DALI offer the possibility of Touch DIM operation. The QTi platform now enables up to 20 ECGs or LED driver to be dimmed using commercial push-buttons with no problem.

1.2 Dimming up to 4 DALI ECGs or DALI- LED driver with one Touch DIM sensor

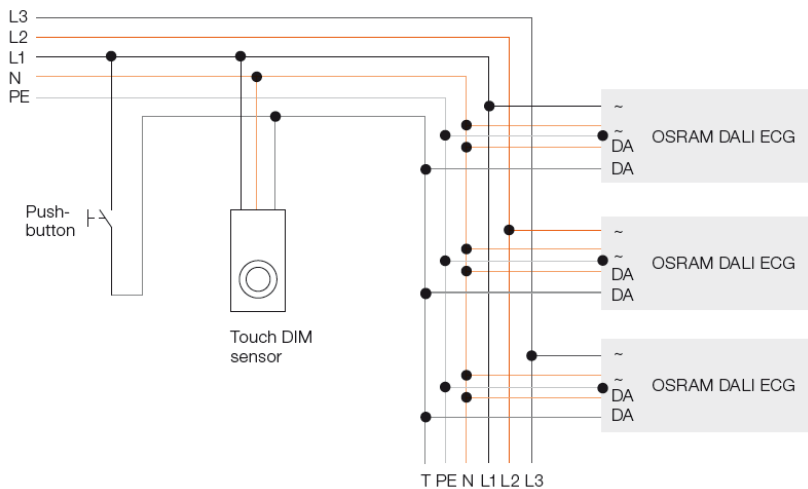

2. Corridor Function and parametrization options



2.1 Description Corridor Function

It is possible to connect the DALI-ECG/DALI-LED drivers directly to commercially available motion sensors. The Corridor Function is triggered by a switching signal, i.e. the voltage of the supply line (220-240 V, 50/60 Hz) is switched to the DALI control line inputs (DA, DA; see the diagram below). A preset „out-of-the-box” luminous flux program launches upon triggering. This can be individually adjusted via OSRAM DALI Wizard and DALI magic. Three light value ranges and six time ranges are available for this purpose.

Several DALI-ECG/DALI-LED drivers can be synchronized in an installation via the frequency of the mains voltage (50/60 Hz). The maximum number of ECGs in an installation is only limited by the sum of the inrush current surges from the individual ECGs.

Advantage:

Development of new applications (stairwells, corridors, large storage facilities, ...) with the possibility for saving energy and achieving high energy efficiency.

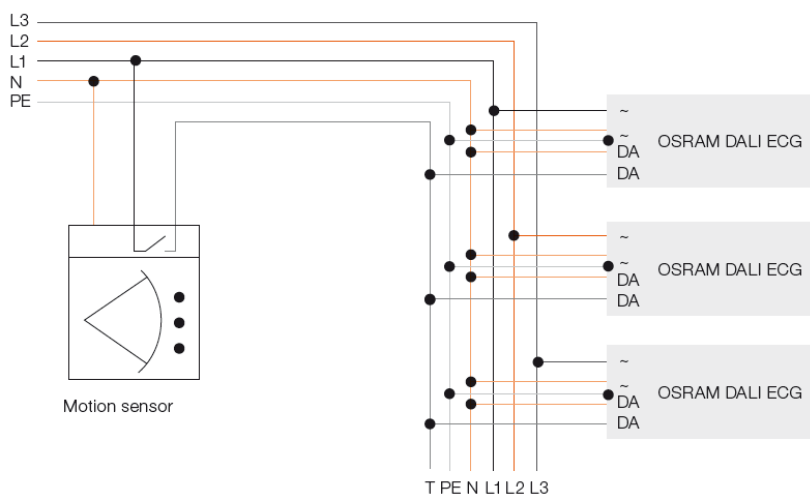

2.2 Activating the Corridor Function

Activate the Corridor Function by permanently applying the supply voltage (220-240 V) to the DALI input of the ECG for at least 120 seconds (50 Hz) and 100 seconds (60 Hz), respectively.

2.3 Changing from the Corridor Function to the Touch DIM Function

It is possible to change from the Corridor Function to the Touch DIM Function by **briefly pressing a push-button 5 times** (at the DALI input, 220-240 V) **within 3 seconds**. For **reliable leaving** of the corridor function it is a must to have a **minimum time of 0.5 sec. in between the 5 individual push button pressings**. The same recommendation fits for the Touch DIM RC solution.

2.4 Setting Corridor Function parameters

The Corridor Functions are easily programmable with the DALI magic/Wizard i.e. the programmed settings (e.g. extent of the three light ranges, duration of the six time ranges) remain saved in the DALI ECG.

Corridor Function phasing (general and factory setting)

General curve:

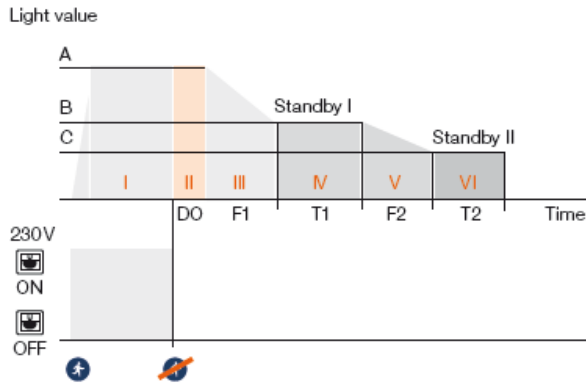

Three dimming ranges (1...100 %), free parameterization of time (I...VI) using DALI magic.

Factory setting:

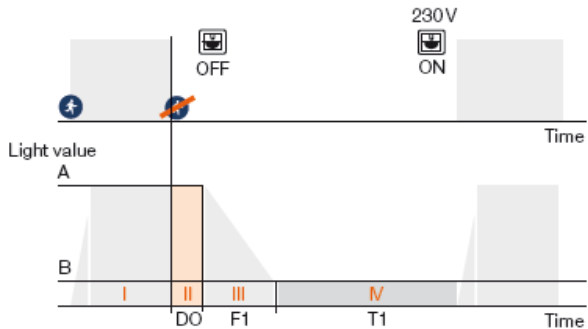

Factory-set parameters:
 A: 100 %, D0: 120 s, F1: 32 s
 B: 10 %, T1: unlimited

2.5 Synchronisation of *Touch DIM*

If a large number of DALI ECG with *Touch DIM* is operated in a system there is a chance that an ECG will operate out of synchronism with the others (= different dimming level setting or different switching state).

Synchronism can be restored as follows:

1. Step: **Long** press of the switch (> 0,5 s) → all the lamps are switched on
2. Step: **Short** press of the switch (< 0,5 s) → all the lamps are switched off
3. Step: **Long** press of the switch (> 0,5 s) → all the lamps are switched on at minimum dimmer setting and fade up
4. Step: Double-click (2x within 0,4 s) → store value (OPTIONAL)

After these three steps – **long-short-long** – all the ECGs will be back in synchronism.

Note:

Touch DIM is designed for manual control; it is not suitable for a connection to an automation.



Driver LC 20W 100–1050mA 44V o4a NF SR EXC3

excite series

Product description

- Independent constant current LED Driver
- Dimmable via DALI-2
- Dimming range 1 to 100 % (min. 5 mA)
- Output current adjustable between 100 – 1,050 mA with DALI or NFC
- Max. output power 20 W
- Up to 85 % efficiency
- Power input on stand-by < 0.4 W
- Nominal lifetime up to 100,000 h
- 5 years guarantee (conditions at www.tridonic.com)



Housing properties

- Casing: polycarbonate, white
- Type of protection IP20
- Toolless mounting of strain relief

Interfaces

- Near field communication (NFC)
- one4all (DALI-2 DT 6, switchDIM, corridorFUNCTION V2)

Functions

- Adjustable output current in 1-mA-steps (NFC, DALI-2)
- Constant light output function (CLO)
- Protective features (overtemperature, short-circuit, overload, no-load)
- Surge protection voltage 1 kV (L – N)
- Suitable for emergency escape lighting systems acc. to EN 50172
- For cable cross-sections up to 2.5 mm²

Benefits

- Flexible configuration via companionSUITE (NFC, DALI-2)
- Application-oriented operating window for maximum compatibility
- New strain relief concept – fast mounting and pre-assembled connection of the LED load possible

Typical applications

- For applications in downlight and decorative luminaires

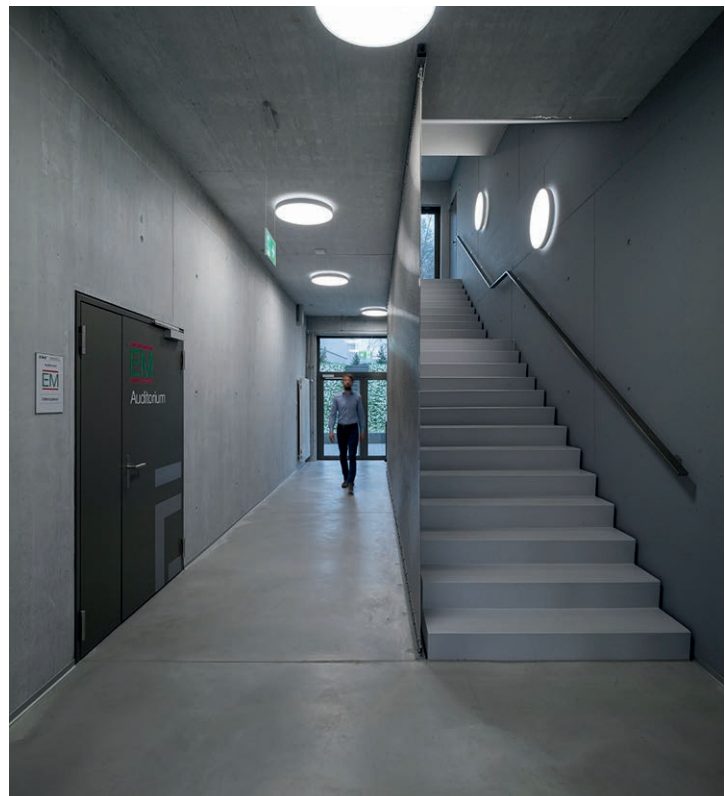
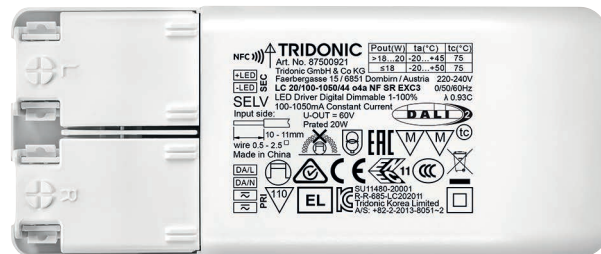

Standards, page 4



Driver LC 20W 100–1050mA 44V o4a NF SR EXC3 excite series

Technical data

Rated supply voltage	220 – 240 V
AC voltage range	198 – 264 V
DC voltage range	176 – 270 V
Mains frequency	0 / 50 / 60 Hz
Overvoltage protection	320 V AC, 48 h
Typ. current (at 230 V, 50 Hz, full load) ^① ②	112 mA
Typ. current (220 V, 0 Hz, full load, 100 % dimming level) ^②	110 mA
Leakage current (at 230 V, 50 Hz, full load) ^① ②	< 700 µA
Max. input power	24.2 W
Typ. efficiency (at 230 V / 50 Hz / full load) ^②	83.5 %
λ (at 230 V, 50 Hz, full load) ^①	0.93C
Typ. power consumption on stand-by ^③	< 0.4 W
Typ. input current in no-load operation	< 25 mA
Typ. input power in no-load operation	0.9 W
In-rush current (peak / duration)	10 A / 80 µs
THD (at 230 V, 50 Hz, full load) ^①	< 10 %
Starting time (at 230 V, 50 Hz, full load) ^①	< 0.66 s
Starting time (DC mode)	< 0.4 s
Switchover time (AC/DC) ^③	< 0.4 s
Turn off time (at 230 V, 50 Hz, full load)	< 0.2 s
Starting time (stand-by)	< 0.5 s
Output current tolerance ^④	± 5 %
Max. output current peak (non-repetitive) ^⑥	≤ Output current + 20 %
Output LF current ripple (< 120 Hz)	± 5 %
Output P _{st} LM (at full load)	≤ 1
Output SVM (at full load)	≤ 0.4
Max. output voltage (U-OUT)	60 V
Dimming range	1 – 100 % (min. 5 mA)
Mains surge capability (between L – N)	1 kV
Mains surge capability (between L/N – PE)	2 kV
Surge voltage at output side (against PE)	3 kV
Type of protection	IP20
Lifetime	up to 100,000 h
Guarantee (conditions at www.tridonic.com)	5 years
Dimensions L x W x H	120 x 51 x 29 mm

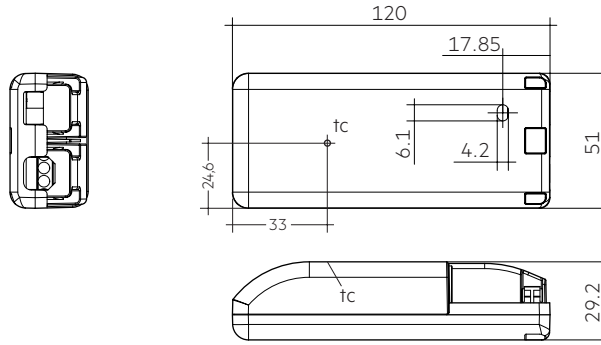

Ordering data

Type	Article number	Packaging carton	Packaging low volume	Packaging high volume	Weight per pc.
LC 20/100-1050/44 o4a NF SR EXC3	87500921	10 pc(s).	180 pc(s).	2,160 pc(s).	0.104 kg

Specific technical data

Type	Output current ^①	Min. forward voltage	Max. forward voltage	Max. output power	Typ. power consumption (at 230 V, 50 Hz, full load)	Typ. current consumption (at 230 V, 50 Hz, full load)	Max. casing temperature t _c	Ambient temperature t _a max.
Max. output power ≤ 18 W								
LC 20/100-1050/44 o4a NF SR EXC3	100 mA	15.0 V	44.0 V	4.4 W	6.7 W	44 mA	75 °C	-20 ... +50 °C
	200 mA	7.5 V	44.0 V	8.8 W	11.2 W	61 mA	75 °C	-20 ... +50 °C
	300 mA	7.0 V	44.0 V	13.2 W	15.9 W	79 mA	75 °C	-20 ... +50 °C
	400 mA	7.0 V	44.0 V	17.6 W	20.6 W	97 mA	75 °C	-20 ... +50 °C
	500 mA	7.0 V	36.0 V	18.0 W	21.1 W	100 mA	75 °C	-20 ... +50 °C
	600 mA	7.0 V	30.2 V	18.1 W	21.3 W	100 mA	75 °C	-20 ... +50 °C
	700 mA	7.0 V	25.8 V	18.1 W	21.4 W	100 mA	75 °C	-20 ... +50 °C
	800 mA	7.0 V	22.6 V	18.1 W	21.4 W	100 mA	75 °C	-20 ... +50 °C
	900 mA	7.0 V	20.0 V	18.1 W	21.3 W	100 mA	75 °C	-20 ... +50 °C
	1050 mA	7.0 V	17.1 V	18.0 W	21.6 W	101 mA	75 °C	-20 ... +50 °C
Max. output power > 18 W								
LC 20/100-1050/44 o4a NF SR EXC3	500 mA	36.0 V	40.0 V	20.0 W	23.3 W	108 mA	75 °C	-20 ... +45 °C
	600 mA	30.2 V	33.4 V	20.0 W	23.4 W	109 mA	75 °C	-20 ... +45 °C
	700 mA	25.8 V	28.5 V	20.0 W	23.3 W	108 mA	75 °C	-20 ... +45 °C
	800 mA	22.6 V	25.0 V	20.0 W	23.3 W	109 mA	75 °C	-20 ... +45 °C
	900 mA	20.0 V	22.2 V	20.0 W	23.6 W	110 mA	75 °C	-20 ... +45 °C
	1050 mA	17.1 V	19.0 V	20.0 W	24.2 W	112 mA	75 °C	-20 ... +45 °C

① Valid at 100 % dimming level.

② Depending on the selected output current.

③ Depending on the DALI traffic at the interface.

④ Output current is mean value.

⑤ Valid for immediate change of power supply type otherwise the starting time is valid.

⑥ For output current range 100 – 250 mA, max. output current peak (non-repetitive) ≤ 250 mA.

1. Standards

EN 55015
EN 61000-3-2
EN 61000-3-3
EN 61000-4-4
EN 61000-4-5
EN 61347-1
EN 61347-2-13
EN 62384
EN 61547
EN 60598-1
EN 62386-101 (DALI-2)
EN 62386-102 (DALI-2)
EN 62386-207 (DALI-2)

According to EN 50172 for use in central battery systems

According to EN 60598-2-22 suitable for emergency lighting installations

2. Thermal details and lifetime

2.1 Expected lifetime

Expected lifetime					
Type	Load range	ta	40 °C	45 °C	50 °C
LC 20/100-1050/44 o4a NF SR EXC3	≤ 18 W	tc	65 °C	70 °C	75 °C
		Lifetime	> 100,000 h	75,000 h	50,000 h
	> 18 – 20 W	tc	70 °C	75 °C	X
		Lifetime	75,000 h	50,000 h	X

The LED Driver is designed for a lifetime stated above under reference conditions and with a failure probability of less than 10 %.

The relation of tc to ta temperature depends also on the luminaire design.

If the measured tc temperature is approx. 5 K below tc max., ta temperature should be checked and eventually critical components (e.g. ELCAP) measured. Detailed information on request.

3. Installation / wiring

3.1 Circuit diagram

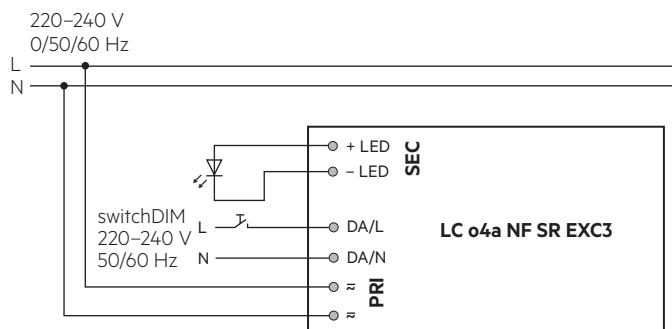
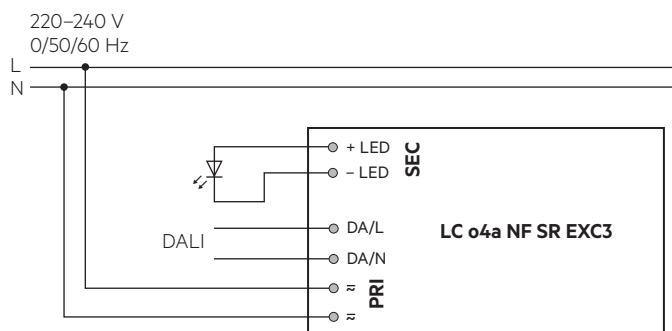

3.2 Wiring type and cross section

Mains supply wires

Stranded wire or solid wire from 0.5 to 2.5 mm² may be used for wiring. Strip 10–11 mm of insulation from the cables to ensure perfect operation of the push terminals.

Use one wire for each terminal connector only.
Use each strain relief channel for one cable only.

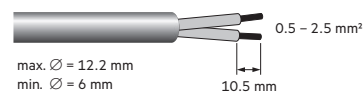

Secondary wires (LED module)

The wiring can be in stranded wires with ferrules or solid with a cross section of 0.5–1.5 mm².

Strip 8.5–9.5 mm of insulation from the cables to ensure perfect operation of the push-wire terminals.

Use one wire for each terminal connector only.
Use each strain relief channel for one cable only.

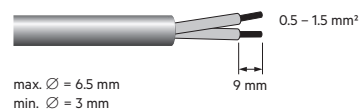

3.3 Loose wiring

Supply/DALI

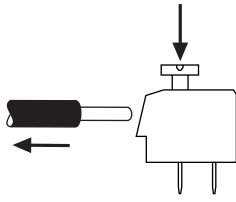

LED module

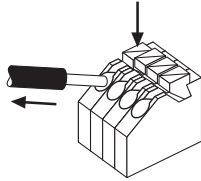

Press down the "push button" and remove the cable from front.

3.4 Mounting of strain relief

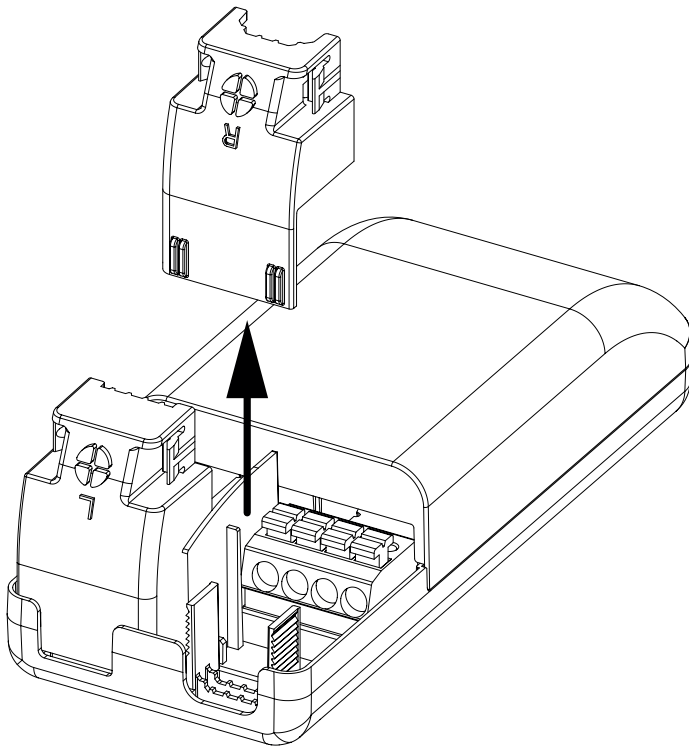

1. Loose strain relief elements from delivery position
2. Wiring the device
3. Push on strain relief element

3.5 Releasing the strain relief

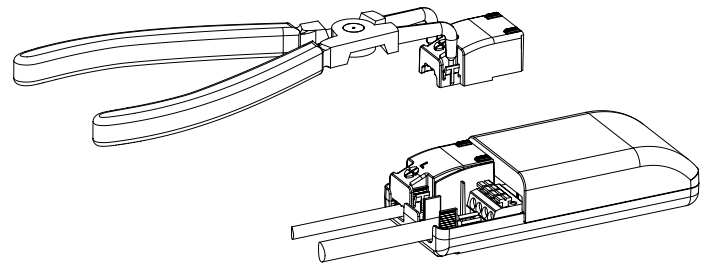

1. Insert release tool device into cut-out, e.g. KNIPEX 46 21 A21 Seeger ring pliers or screwdriver
2. Remove strain relief element

3.6 Fixing conditions

Dry, acidfree, oilfree, fatfree. It is not allowed to exceed the maximum ambient temperature (t_a) stated on the device. Minimum distances stated below are recommendations and depend on the actual luminaire. Device is not suitable for fixing in corner.

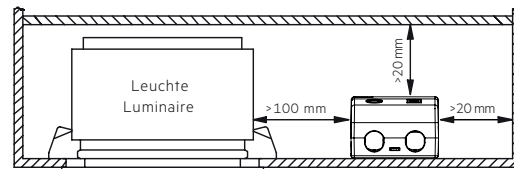

3.7 Wiring guidelines

- Run the secondary lines separately from the mains connections and lines to achieve good EMC performance.
- The max. secondary cable length is 2 m (4 m circuit).
- For good EMC performance, keep the LED wiring as short as possible.
- To comply with the EMC regulations run the secondary wires (LED module) in parallel.
- Secondary switching is not permitted.
- The LED Driver has no inverse-polarity protection on the secondary side. Wrong polarity can damage LED modules with no inverse-polarity protection.
- Wrong wiring of the LED Driver can lead to malfunction or irreparable damage.
- To avoid the damage of the Driver, the wiring must be protected against short circuits to earth (sharp edged metal parts, metal cable clips, louver, etc.).

3.8 Replace LED module

1. Mains off
2. Remove LED module
3. Wait for 10 seconds
4. Connect LED module again

Hot plug-in or secondary switching of LEDs is not permitted and may cause a very high current to the LEDs.

3.9 Installation note

Max. torque at the clamping screw: 0.5 Nm / M4

4. Electrical values

4.1 Operating window

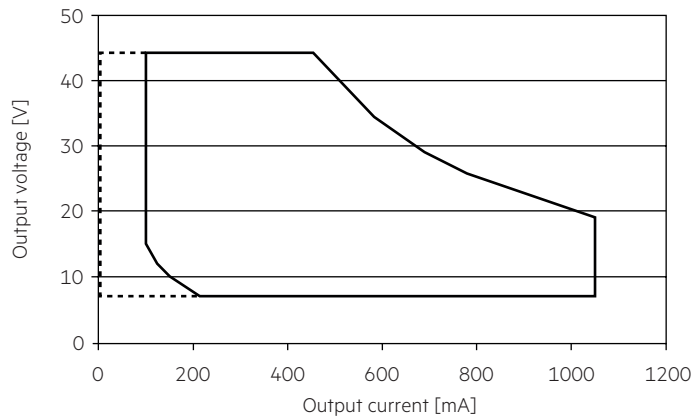

— Operating window 100 %
- - - - - Operating window dimmed

Make sure that the LED Driver is operated within the given window under all operating conditions. Special attention needs to be paid at dimming and DC emergency operation as the forward voltage of the connected LED modules varies with the dimming level, due to the implemented amplitude dimming technology. Coming below the specified minimum output voltage of the LED Driver may cause the device to shut-down. See chapter "6.3 Light level in DC operation" for more information.

4.2 Efficiency vs load

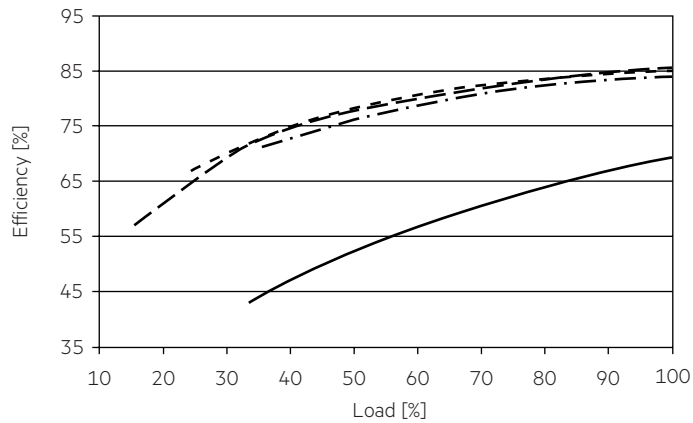

4.3 Power factor vs load

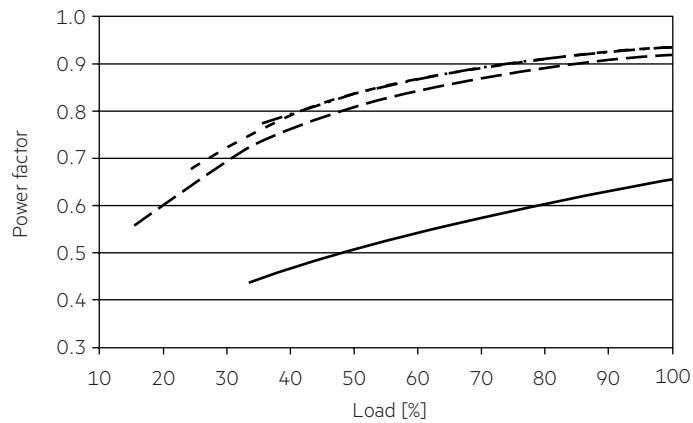

4.4 Input power vs load

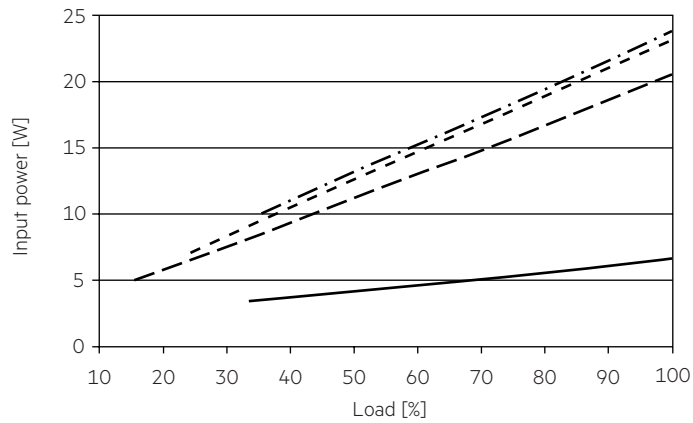

4.5 Input current vs load

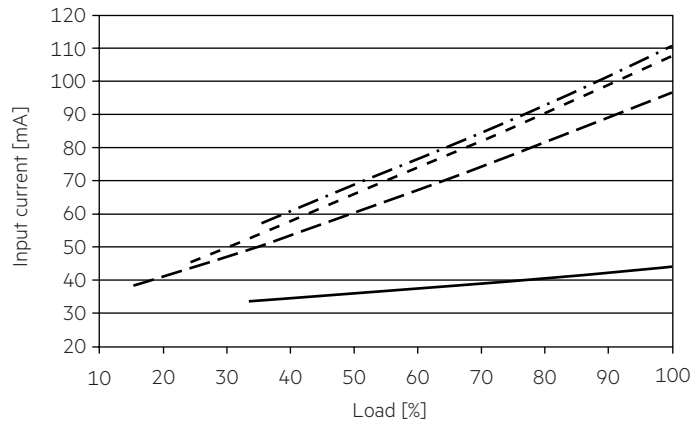

4.6 THD vs load

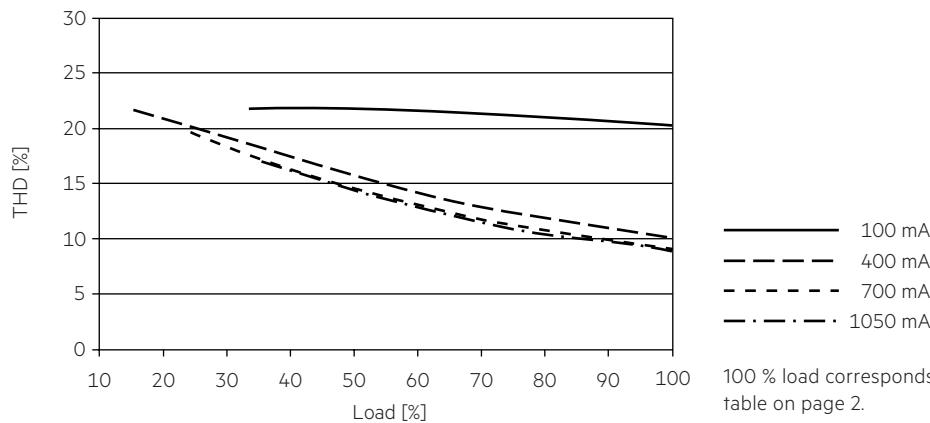

100 % load corresponds to the max. output power (full load) according to the table on page 2.

4.7 Maximum loading of automatic circuit breakers in relation to inrush current

Automatic circuit breaker type	C10	C13	C16	C20	B10	B13	B16	B20	Inrush current
Installation Ø	1.5 mm ²	1.5 mm ²	2.5 mm ²	2.5 mm ²	1.5 mm ²	1.5 mm ²	2.5 mm ²	2.5 mm ²	I_{max} time
LC 20/100-1050/44 o4a NF SR EXC3	70	91	112	140	70	91	112	140	10 A 80 µs

These are max. values calculated out of continuous current running the device on full load.
There is no limitation due to inrush current.
If load is smaller than full load for calculation only continuous current has to be considered.

4.8 Harmonic distortion in the mains supply (at 230 V / 50 Hz and full load) in %

	THD	3.	5.	7.	9.	11.
LC 20/100-1050/44 o4a NF SR EXC3	< 10	< 10	< 8	< 6	< 5	< 3

4.9 Insulation matrix

	Mains	Output	one4all
Mains	–	••	•
Output	••	–	••
one4all	•	••	–

- Represents basic insulation
- Represents double or reinforced insulation

4.10 Dimming

Dimming range 1% to 100 %
Digital control with:

- DALI signal: 16 bit Manchester Code
Speed 10% to 100% in 0.2 s
Programmable parameter:
Minimum dimming level
Maximum dimming level
Default minimum = 1%
Programmable range $1\% \leq \text{MIN} \leq 100\%$
Default maximum = 100%
Programmable range $100\% \geq \text{MAX} \geq 1\%$

Dimming curve is adapted to the eye sensitiveness.

4.11 Dimming characteristics

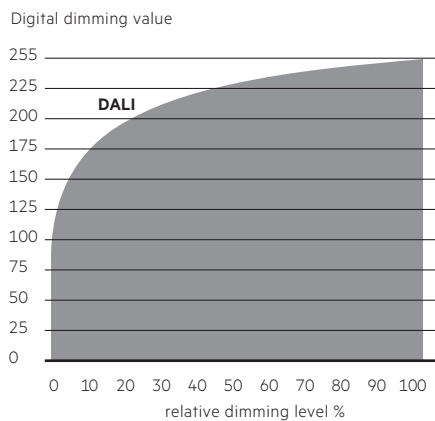

Dimming characteristics as seen by the human eye.

5. Software / Programming / Interfaces

5.1 Software / programming

With appropriate software and interface different functions can be activated and various parameters can be configured in the LED Driver. The Driver supports the following software and interfaces:

Software / hardware for configuration:

- companionSUITE (deviceGENERATOR, deviceCONFIGURATOR, deviceANALYSER)
- masterCONFIGURATOR

Interfaces for data transfer:

- NFC
- Control input DALI
- Control input switchDIM

5.2 Nearfield communication (NFC)

The NFC Interface allows wireless communication with the LED Driver. This interface offers the option to write configuration and to read configuration, errors and events with the companionSUITE. A correct communication between the LED Driver and the NFC antenna can only be guaranteed if the antenna is placed directly on the Driver. Any material placed between the LED Driver and the NFC antenna can cause a deterioration of the communication quality. After programming the device via NFC power up the device one time for one second till the deviceANALYSER can read out the parameters. We recommend the use of following NFC antenna: www.tridonic.com/nfc-readers

NFC is complied with ISO/IEC 15963 standard.

5.3 Control input DALI

The control input is non-polar for digital control signals (DALI). The control signal is not SELV. The control cable has to be installed in accordance to the requirements of low voltage installations.

Digital control with:

- DALI signal: 16 bit

Dimming is realized by amplitude dimming.

5.4 Control Input switchDIM

A standard pushbutton (switchDIM) can be wired on the terminals (DA/N and DA/L). Integrated switchDIM function allows a direct connection of a pushbutton for dimming and switching. Brief push (< 0.6 s) switches LED Driver ON and OFF. The dimm level is saved at power-down and restored at power-up. When the pushbutton is held, LED modules are dimmed. After repush the LED modules are dimmed in the opposite direction. In installations with LED Drivers with different dimming levels or opposite dimming directions (e.g. after a system extension), all LED Drivers can be synchronized to 50% dimming level by a 10 s push. Use of pushbutton with indicator lamp is not permitted.

6. Functions

☉ companionSUITE:













DALI-USB, NFC

The companionSUITE with deviceGENERATOR, deviceCONFIGURATOR and deviceANALYSER is available via our WEB page:
<https://www.tridonic.com/com/en/products/companionsuite.asp>

◇ masterCONFIGURATOR:

DALI-USB

The masterCONFIGURATOR is available via our WEB page:
<https://www.tridonic.com/com/en/software-masterconfigurator.asp>

Icon	Function	NFC	DALI-2
	Device operating mode	☉	☉ ◇
	Device reset command	☉	-
	corridorFUNCTION	☉	☉ ◇
	Constant light output (CLO)	☉	☉ ◇
	DC Level	☉	☉ ◇
	LED current	☉	☉ ◇
	OEM Identification	☉	☉ ◇
	OEM GTIN	☉	☉ ◇
	Enhanced power on level (ePOL)	☉	☉ ◇
	DALI default parameters	☉	☉ ◇
	Scenes and groups	☉	☉ ◇
	Power up fading	☉	☉ ◇

6.1 LED current



The LED output current must be adapted to the connected LED module. The value is limited by the current range of the respective device.

The priority for current adjustment methods is NFC / DALI (highest priority).

Minimum output current is default.

6.2 corridorFUNCTION



A motion detector (corridorFUNCTION) can be wired on the terminals (DA/N and DA/L).

With the corridorFUNCTION and a commercially available motion detector, it is easy to adapt the lighting in one area to its use.

That is, when the area is entered by a person, the lighting dims instantly to a certain brightness and is available in desired strength.

After the area is left by the person, the brightness dims slowly to a smaller value or switches off completely.

The individual parameters of the desired profile, such as brightness values or delay times, can be adjusted flexibly and individually.

To activate the corridorFUNCTION without using software a voltage of 230 V has to be applied at the DA/N and DA/L connection.

The unit will then switch automatically to the corridorFUNCTION.

corridorFUNCTION is a very simple tool for controlling gears with conventional pushbuttons or motion sensors.

To ensure correct operation a sinusoidal mains voltage with a frequency of 50 Hz or 60 Hz is required at the control input.

Special attention must be paid to achieving clear zero crossings.

Serious mains faults may impair the operation of corridorFUNCTION.

Note:

By using corridorFUNCTION programming and monitoring via DALI is always possible.

6.3 Constant Light Output (CLO)



With this function the light output of the LED module can be kept equal over the lifetime.

The light output of an LED module reduces over the course of its lifetime.

The Constant Light Output (CLO) function compensates for this natural decline by constantly increasing the output current of the LED Driver throughout its lifetime.

CLO shall be achieved by limitation of the LED current at the commissioning of the LED Driver and providing a linear interpolation of the current over the time, depending on the data points given by the user.

6.4 Light level in DC operation



The LED Driver is designed to operate on DC voltage and pulsed DC voltage. For a reliable operation, make sure that also in DC emergency operation the LED Driver is run within the specified conditions as stated in chapter "4.1 operating window".

Light output level in DC operation is programmable (0; 1 – 100 %). Default value is 100 % (EOFi = 0.95).

The voltage-dependent input current of Driver incl. LED module is depending on the used load.

The voltage-dependent no-load current of Driver (without or defect LED module) is for:

AC: < 25 mA

DC: < 7 mA

6.5 Power-up fading



The power-up function offers the opportunity to modify the on behavior.

The time for fading on can be adjusted in a range of 0.2 to 16 seconds.

According to this value, the device dims either from 0 % up to the power-on level.

By factory default no fading time is set (= 0 seconds).

7. Protective features

7.1 Short-circuit behaviour

In case of a short-circuit at the LED output the LED output is switched off. After restart of the LED Driver the output will be activated again. The restart can either be done via mains reset or via the DALI interface.

7.2 No-load operation

The LED Driver will not be damaged in no-load operation. The output will be deactivated and is therefore free of voltage. If a LED load is connected the device has to be restarted before the output will be activated again.

7.3 Overload protection

If the maximum load is exceeded by a defined internal limit, the LED Driver turns off the LED output. After restart of the LED Driver the output will be activated again. The restart can either be done via mains reset or via the DALI interface.

7.4 Overtemperature protection

The LED Driver is protected against temporary thermal overheating. If the temperature limit is exceeded the LED Driver will switch off. It restarts automatically. The temperature protection is activated above $t_{c\ max}$. The activation temperature differs depending on the LED load. On DC operation this function is deactivated to fulfill emergency requirements.

7.5 Insulation

The LED Driver is double insulated.

8. Miscellaneous

8.1 Insulation and electric strength testing of luminaires

Electronic devices can be damaged by high voltage. This has to be considered during the routine testing of the luminaires in production.

According to IEC 60598-1 Annex Q (informative only!) or ENEC 303-Annex A, each luminaire should be submitted to an insulation test with 500 V_{DC} for 1 second. This test voltage should be connected between the interconnected phase and neutral terminals and the earth terminal. The insulation resistance must be at least 2 MΩ.

As an alternative, IEC 60598-1 Annex Q describes a test of the electrical strength with 1500 V_{AC} (or 1.414 x 1500 V_{DC}). To avoid damage to the electronic devices this test must not be conducted.

8.2 Conditions of use and storage

Humidity: 5% up to max. 85%,
not condensed
(max. 56 days/year at 85%)

Storage temperature: -40 °C up to max. +80 °C

The devices have to be acclimatised to the specified temperature range (t_a) before they can be operated.

The LED Driver is declared as inbuilt LED controlgear, meaning it is intended to be used within a luminaire enclosure. If the product is used outside a luminaire, the installation must provide suitable protection for people and environment (e.g. in illuminated ceilings).

8.3 Additional information

Additional technical information at www.tridonic.com → Technical Data

Lifetime declarations are informative and represent no warranty claim. No warranty if device was opened.